

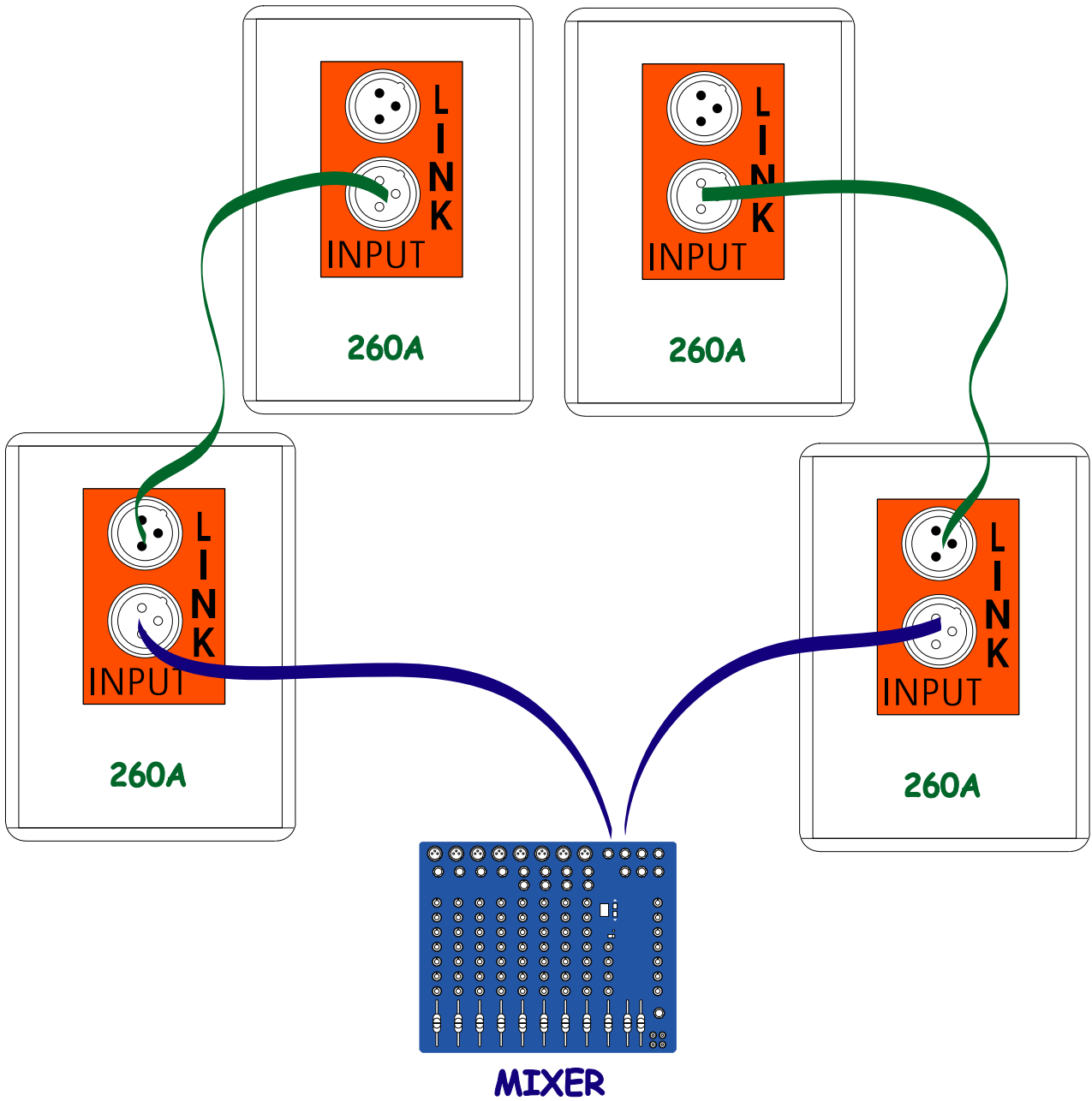

Parallel connection of two or more 260A

always use balanced shielded cables



MIXER L/R OUTPUTS 260A INPUTS
 260A OUTPUTS INPUTS of other 260A



Two 260A + one active subwoofer

always use balanced shielded cables

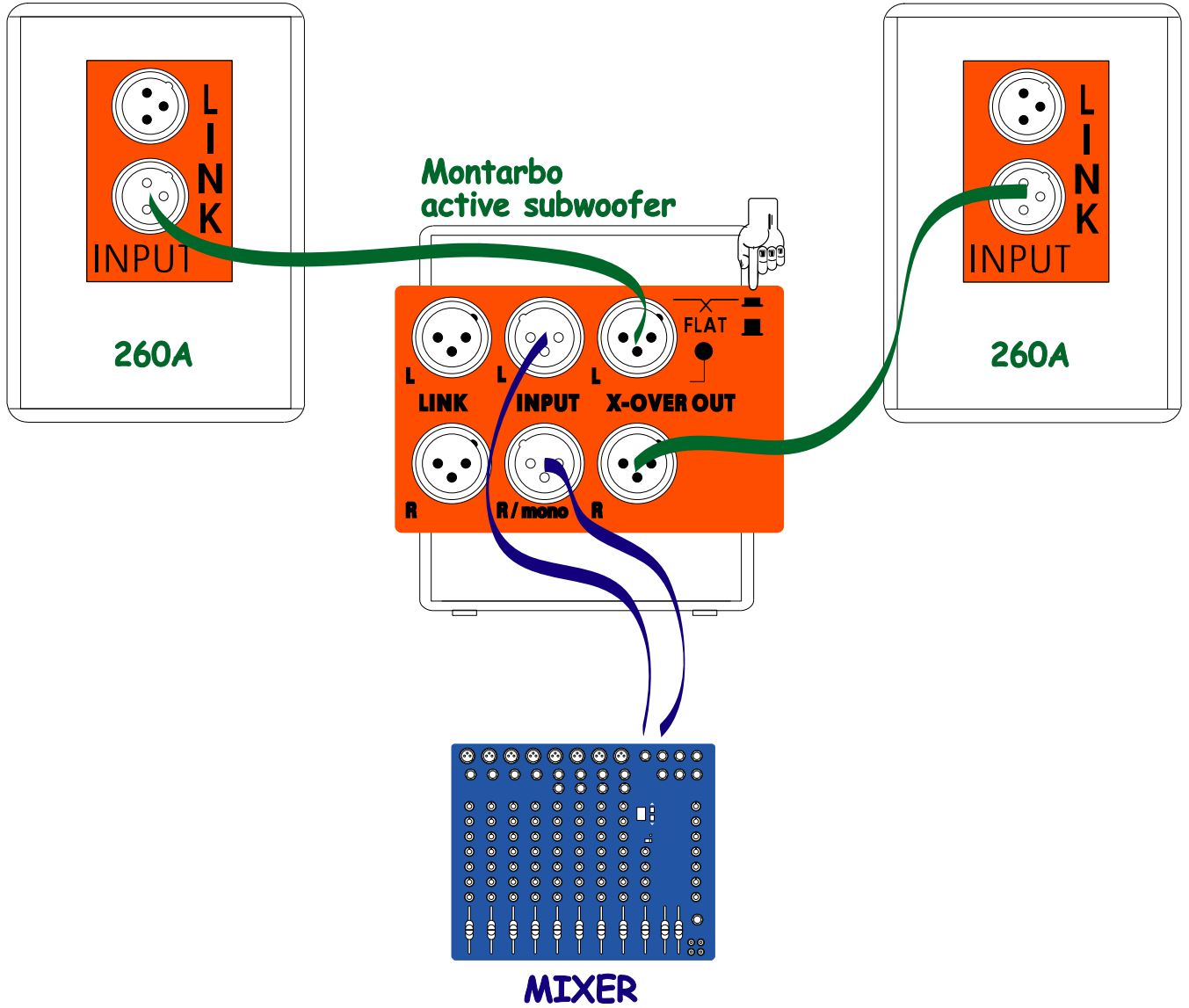

MIXER L/R OUTPUTS → SUBWOOFER L/R INPUTS
 SUBWOOFER L/R X-over OUTPUTS → 260A INPUTS



Two 260A + two active subwoofers

always use balanced shielded cables

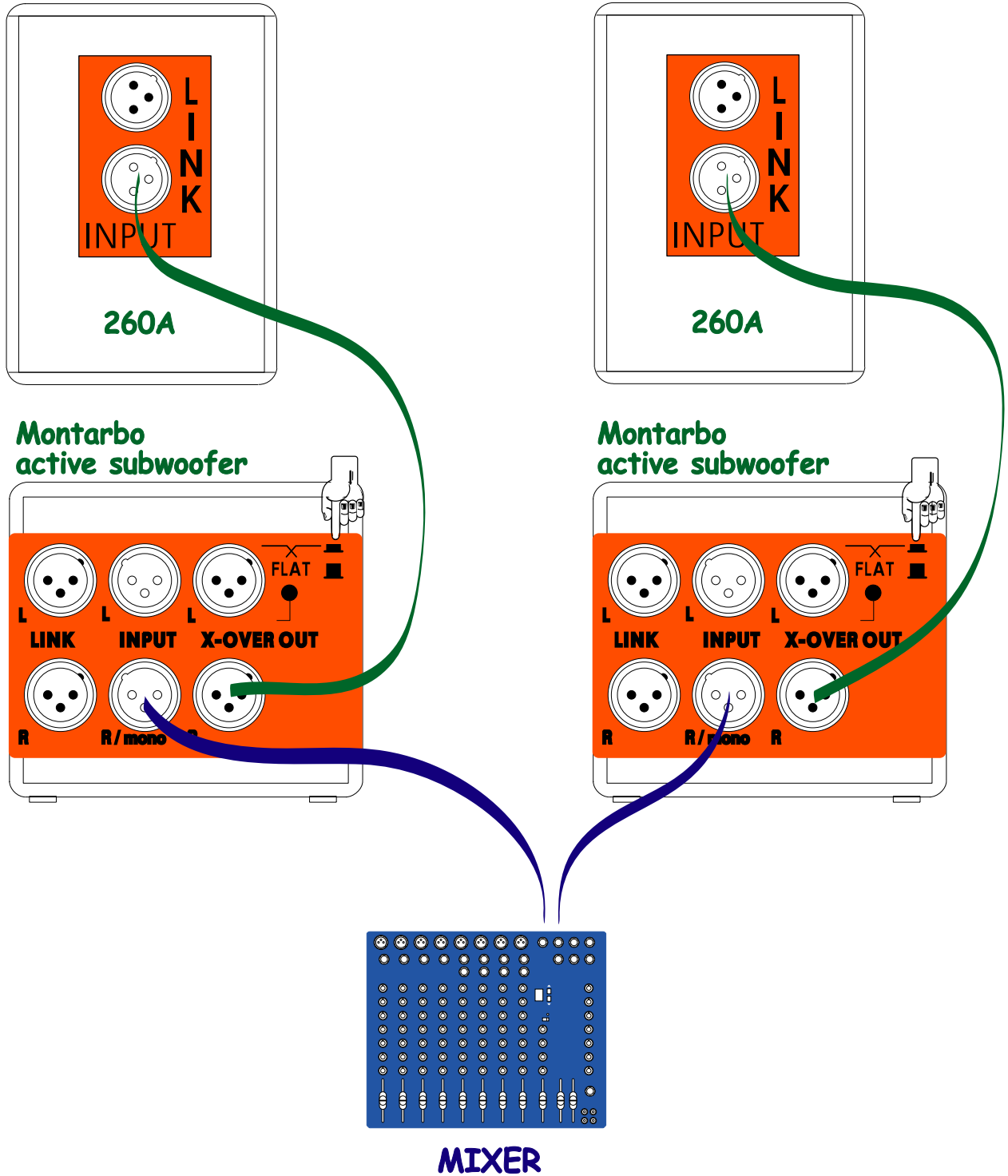

MIXER L/R OUTPUTS → SUBWOOFERS 'R/mono' INPUTS
 SUBWOOFERS 'R' X-over OUTPUTS → 260A INPUTS